



# MAXX ICE

SERVICE, INSTALLATION, AND INSTRUCTION MANUAL



**MIM452 - MIM600 - MIM1000**  
**AUTOMATIC COMMERCIAL ICE CUBE MACHINE**  
PLEASE READ CAREFULLY



# MAXX ICE



## Contents

ICE MAKER SAFETY . . . . .	2
IMPORTANT SAFEGUARDS . . . . .	3-4
MAJOR FEATURES . . . . .	4
TECHNICAL INFORMATION . . . . .	4
INTRODUCTION . . . . .	5
COMPONENT INFORMATION. . . . .	5
ICE MAKER INSTALLATION. . . . .	6-10
Unpacking . . . . .	6
Remove Packaging Material . . . . .	6
Location Requirements . . . . .	6-7
Typical Installation of Ice Storage Bin. . . . .	8
Electrical Requirements . . . . .	9
Connecting the power supply line . . . . .	9
Water Supply . . . . .	10
Installation Types . . . . .	10
OPERATION . . . . .	11-12
Final Checklist before Operation . . . . .	11
Operating Method . . . . .	11
How the Machine Makes Ice . . . . .	12
Normal Sounds . . . . .	12
Preparing the Ice Maker for Long Storage . . . . .	12
CLEANING AND MAINTENANCE . . . . .	13-15
Exterior Cleaning . . . . .	13
Interior Cleaning . . . . .	13
Water Distribution Tube Cleaning . . . . .	14
Ice-Making System Cleaning . . . . .	14
Condenser Cleaning. . . . .	15
CONTROL PANEL . . . . .	15-16
TROUBLESHOOTING . . . . .	16
TROUBLESHOOTING GUIDE. . . . .	17
NOTES . . . . .	18
FRENCH . . . . .	19-36
SPANISH . . . . .	37-54

Maxx Ice reserves the right to make changes in specifications and design without prior notice.

**NOTICE: Models MIM452/MIM600/MIM1000 are ice-making units and do not include ice storage bins. If you order a bin, please follow this manual and the manual accompanying the bin regarding installation, adjustment of storage bin feet, cleaning, water drainage, etc.**

## ICE MAKER SAFETY

We have provided many important safety messages in this manual and on your appliance. Always read and obey all safety messages.



This is the Safety Alert Symbol. This symbol alerts you to potential hazards that can injure or kill you and others. All safety messages will follow the Safety Alert Symbol and either the words "DANGER", "WARNING" OR "CAUTION".



**DANGER** means that failure to heed this safety statement may result in death or severe personal injury.



**WARNING** means that failure to heed this safety statement may result in extensive product damage, serious personal injury, or death.



**CAUTION** means that failure to heed this safety statement may result in minor or moderate personal injury, or property or equipment damage.

All safety messages will alert you to what the potential hazard is, tell you how to reduce the chance of injury, and let you know what can happen if the instructions are not followed.



### NOTE: IMPORTANT SAFETY INSTRUCTIONS

**WARNING:** To reduce the risk of fire, electric shock or injury, when using your ice maker, follow these basic precautions:

- Plug into grounded 3-prong outlet
- Do not remove grounding prong
- Do not use an adapter
- Do not use an extension cord
- Disconnect power before cleaning
- Disconnect power before servicing
- Replace all panels before operating
- Use 2 or more people to move and install ice maker

## SAVE THESE INSTRUCTIONS



# MAXX ICE

## IMPORTANT SAFEGUARDS



Before the ice maker is used, it must be properly positioned and installed as described in this manual, so read the manual carefully. We strongly recommend that you have a professional install your new machine. The warranty may be affected or voided by an incorrect installation. To reduce the risk of fire, electrical shock or injury when using the ice maker, follow basic precautions, including the following:

### **DANGER**

- It is recommended that a separate circuit, serving only your ice maker, be provided. Use receptacles that cannot be turned off by a switch or pull chain.
- Do not connect or disconnect the electric plug when your hands are wet.
- Never unplug the ice maker by pulling on the power cord. Always grip the plug firmly and pull straight out from the outlet.
- Never clean ice maker parts with flammable fluids. Do not store or use gasoline or other flammable vapors and liquids in the vicinity of this or any other appliance. The fumes can create a fire hazard or explosion.
- Before proceeding with cleaning and maintenance operations, make sure the power line of the unit is disconnected and the water line is shut off. (EXCEPTION: When cleaning the machine's ice making and water systems)
- Before operating, put all the enclosure panels back into their original places.
- Do not touch the evaporator with your hand when the machine is operating.
- Unplug the ice maker or disconnect power before cleaning or servicing. Failure to do so can result in electrical shock or death.
- Do not attempt to repair or replace any part of your ice maker unless it is specifically recommended in this manual. A qualified technician should do all other servicing.

### **WARNING**

- Use two or more people to move and install ice maker. Failure to do so can result in back or other injury.
- To ensure proper ventilation for your ice maker, the front of the unit must be completely unobstructed. Choose a well-ventilated area with temperatures above 50°F (10°C) and below 100°F (38°C). This unit MUST be installed in an area protected from the elements, such as wind, rain, water spray or drips.
- The ice maker should not be located next to ovens, grills or other sources of high heat.
- The ice maker must be installed with all electrical and water connections in accordance with state and local codes. A standard electrical supply against the nameplate rating, properly grounded in accordance with the National Electrical Code and local codes and ordinances is required.
- The fuse (or circuit breaker) size should be 20 amperes for the ice makers.
- It is important for the ice maker to be well leveled for proper operation. You may need to make several adjustments to level it.
- All installations must be in accordance with local plumbing code requirements.
- Make certain that the hoses are not pinched or kinked or damaged during installation.
- Check for leaks after connection.
- Although the unit has been tested at the factory, due to long-term transit and storage, the first batch of cubes must be discarded.
- Remove the packing materials and clean the ice maker before using.
- Turn on the water supply tap before switching on the ice maker. Never turn off the water supply tap when the ice maker is working.
- Except to take ice from the storage bin, keep the bin door closed in order to reduce ice melting and to promote proper ice formation.
- If the ice maker will not be used for a long time, before the next use it must be thoroughly cleaned. Follow carefully any instructions provided for cleaning or use of sanitizing solution. Do not leave any solution inside the ice maker after cleaning.
- DO NOT touch the condenser fins. The condenser fins are sharp and can be easily damaged.

- DO NOT use solvent-based cleaning agents or abrasives on the interior. These cleaners may transmit taste to the ice cubes, or damage or discolor the interior.
- The ice machine cleaner contains acids. DO NOT use or mix with any other solvent-based cleaner products. Use rubber gloves to protect hands. Carefully read the material safety instructions on the container of the ice machine cleaner.
- Do not use this apparatus for other than its intended purpose.

## SAVE THESE INSTRUCTIONS

### Electrical Connection

Do not, under any circumstances, cut or remove the third (ground) prong from the power cord. For personal safety, this appliance must be properly grounded. The power cord of this appliance is equipped with a 3-prong grounding plug that mates with a standard 3-prong grounding wall outlet to minimize the possibility of electric shock hazard from the appliance. Have the wall outlet and circuit checked by a qualified electrician to make sure the outlet is properly grounded. When a standard 2-prong wall outlet is encountered, it is your responsibility and obligation to have it replaced with a properly grounded 3-prong wall outlet. The ice maker should always be plugged into its own individual electrical outlet which has a voltage rating that matches the rating label on the appliance. This provides the best performance and also prevents overloading house wiring circuits which could cause a fire hazard from overheated wires. Never unplug your ice maker by pulling on the power cord. Always grip the plug firmly and pull straight out from the outlet. Repair or replace immediately all power cords that have become frayed or otherwise damaged. Do not use a cord that shows cracks or abrasion damage along its length or at either end. When moving the ice maker, be careful not to damage the power cord.

### Extension Cord

Because of potential safety hazards under certain conditions, it is strongly recommended that you do not use an extension cord with this ice maker.

### Major Features

1. Completely automatic operation.
2. The different colors of the LED display indicate various working modes.
3. The fan motor responds to the ambient temperature. If room temperature is low, the motor will stop working to keep the cooling system in good working condition.
4. Ice cube size is adjustable.
5. Periodically draining water allows more pure ice and keep minimum mineral buildup.
6. A sensitive probe and accurate timer enhance the performance of the ice maker.

### Technical Information

MODEL	MIM452	MIM600	MIM1000
Electrical input	115VAC / 60Hz	230VAC / 60Hz	230VAC / 60Hz
Power consumption (kW·h / 100 lbs of ice)	7.3	6.49	5.8
Ice-making/Ice-harvest rated current	12.4A/15.3A	7.6A/9.85A	9.2A/11.3A
Refrigerant	R404A, 24.5oz.	R404A, 45.8oz.	R404A, 52.9oz.
High/Low side pressure	350psig/190psig	380psig/190psig	400psig/190psig
Unit width x depth x height	30"x 24"x 20. 7/8"	30"x 24"x 20. 7/8"	30"x 24"x 26. 5/8"
Unit weight	340 lbs maximum	155 lbs maximum	194 lbs maximum
Ice-making capability	+400 lbs/day*	+438 lbs/day*	+780 lbs/day*
Ice shape	Cube	Cube	Cube
Ice cube dimensions	3/4"x 1"x 3/4"	3/4"x 1"x 3/4"	3/4"x 1"x 3/4"

\*The actual quantity of ice produced per day can vary with room and water conditions. The technical data and performance indices listed above should be used for reference only. They are subject to change.



# MAXX ICE



## Introduction

MaxxIce Automatic Commercial Ice Cube machines produce hard, crystal-clear, gourmet cube ice. This user's manual is intended as a resource for persons installing, using and servicing. It contains valuable information on safety and maintenance. MaxxIce strongly recommends that this manual be kept in a place where it can be accessed when needed. Every MaxxIce, Ice Cube machine is designed and manufactured according to the highest standards of safety and performance. It meets or exceeds the safety standard of UL563 and sanitation standard NSF12.

The Legacy Companies assumes no liability or responsibility of any kind for products manufactured by MaxxIce, that have been altered in any way, including the use of any parts and/or other components not specifically approved by The Legacy Companies. MaxxIce reserves the right to make design changes and/or improvements at any time. Specifications and designs are subject to change without notice.

## Component Information

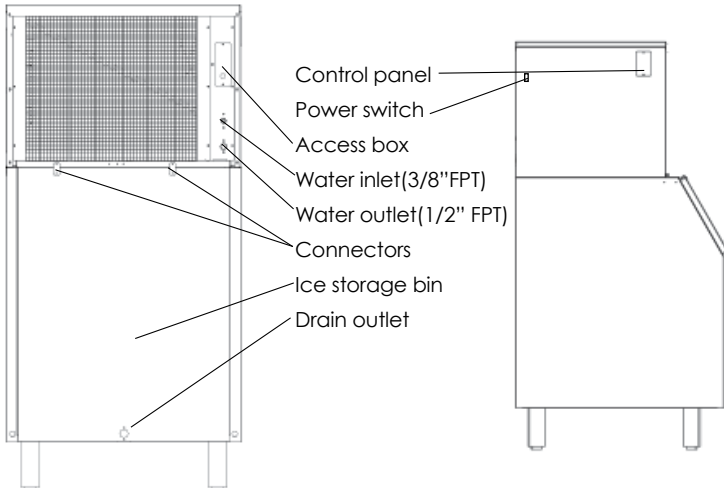
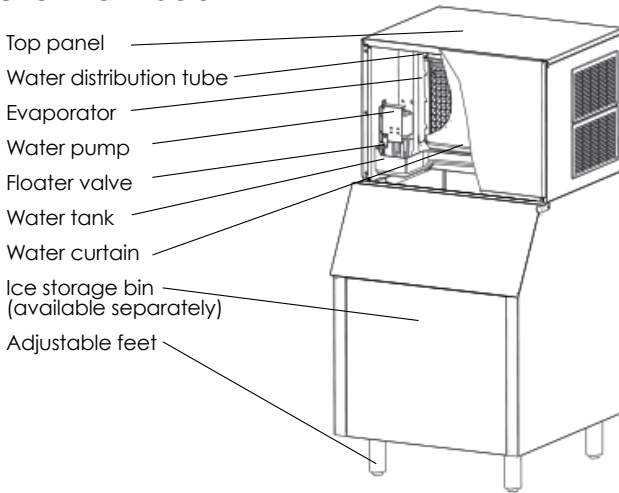

## Ice Maker Installation

### UNPACKING

#### **⚠ WARNING**

#### **Excessive Weight Hazard**

Use two or more persons to move and install ice maker.  
Failure to do so can result in back or other injury.

*This unit is an ice maker only. It requires a separate ice storage bin.*

### REMOVE PACKAGING MATERIALS

**IMPORTANT:** Do not remove any permanent instruction labels or the data label on your ice maker.

Remove tape and glue from your ice maker before using.

- To remove any remaining tape or glue, rub the area briskly with your thumb. Tape or glue residue can also be easily removed by rubbing a small amount of liquid dish soap over the adhesive with your fingers. Wipe with warm water and dry with a soft cloth.
- Do not use sharp instruments, rubbing alcohol, flammable fluids, or abrasive cleaners to remove tape or glue. These products can damage the surface of your ice maker.

### LOCATION REQUIREMENTS

- This ice maker should be installed by qualified personnel.

### Installation Clearance

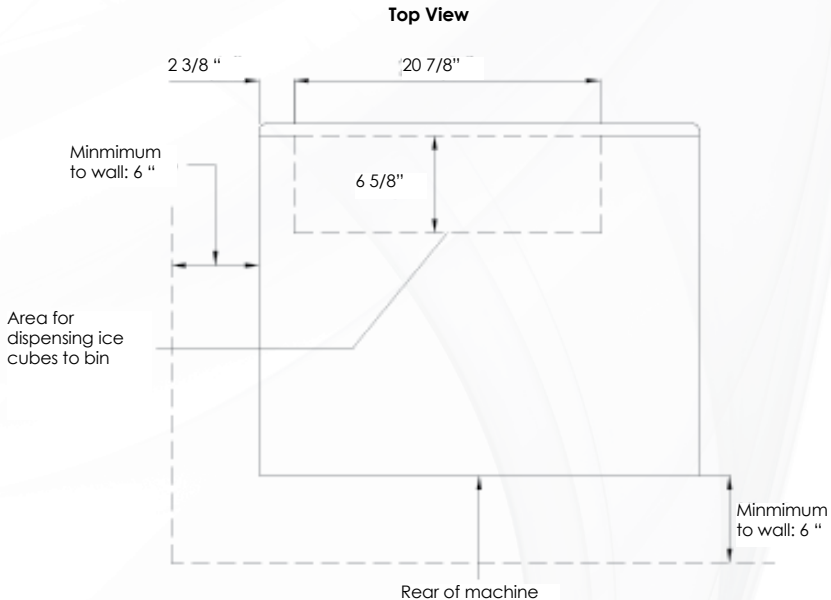



# MAXX ICE



## Ice Maker Installation

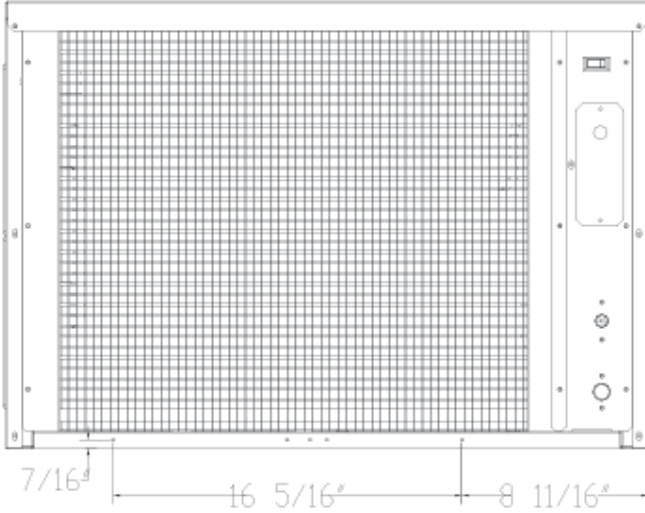

### REAR VIEW

The two holes are for attachment to the ice storage bin. See drawings below.

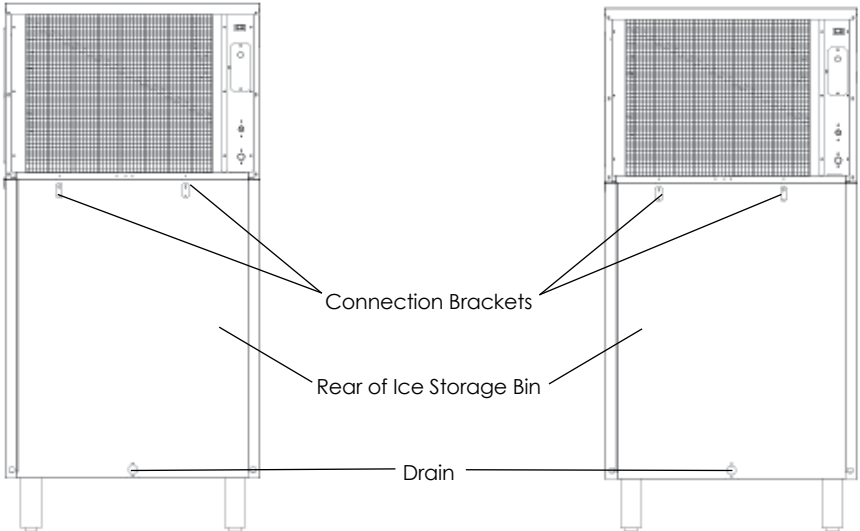



## Ice Maker Installation

### TYPICAL INSTALLATION OF ICE STORAGE BIN

- Two connecting brackets are attached to the upper rear edge of the ice storage bin. Turn the brackets up (180°) and use two screws to connect the main machine and ice storage bin.
- To ensure proper ventilation for your ice maker, you need keep the front of the unit completely unobstructed.
- Choose a well-ventilated area with temperatures above 50°F (10°C) and below 100°F (38°C). This unit **MUST** be installed in an area protected from the elements, such as wind, rain, water spray or drips.
- The unit should not be located next to ovens, grills or other sources of high heat.
- Installation of the ice maker requires a cold water supply inlet of 3/8" (9.5 mm) soft copper tubing with a shut-off valve.
- The ice maker requires a continuous water supply with a minimum pressure of 15 psig and a static pressure not to exceed 80 psig. The temperature of the water feeding into the ice maker should be between 41°F (5°C) and 90°F (32°C) for proper operation.

### **⚠ WARNING**

Normal operating ambient temperature should be between 50°F (10°C) and 100°F (38°C). Normal operating water temperature should be between 41°F (5°C) and 90°F (32°C). Operation of the ice maker for extended periods outside of these normal temperature ranges may affect production capacity.

- In general, it is always a good idea to filter the water. A water filter, if it is of the proper type, can remove taste and odors as well as particles.
- The ice maker must be installed with all electrical and water connections in accordance with state and local codes.
- The ice maker and bin should be located on a firm and level surface. It is important for the ice maker to be perfectly level for proper operation; otherwise water may not flow properly through the evaporator (ice mold). Ice production will be less than expected and operation will be noisy.
- The feet of most bins can be rotated to adjust the height if necessary. Follow instructions accompanying the bin you purchase.

# MAXX ICE

## Ice Maker Installation

### ELECTRICAL REQUIREMENTS

#### **⚠ DANGER ⚠**



Plug into a grounded 3-prong outlet.  
Never remove the grounding prong from the plug.  
Never use an adapter.  
Never use an extension cord.  
Failure to follow these instructions can result in fire, electrical shock or death.

Before you move your ice maker into its final location, be sure you have the proper electrical connection. Refer to the nameplate rating at the left of the ice machine to make sure proper voltage, properly grounded in accordance with National Electrical Code and local codes and ordinances, is required. The ice maker should always be plugged into its own individual electrical outlet. It is recommended that a separate circuit, serving only your ice maker, be provided. Use receptacles that cannot be turned off by a switch or pull chain. The fuse (or circuit breaker) size should be 20 amperes.

#### Recommended grounding method

For your personal safety, this appliance must be grounded. The power supply cord (not included) must have a 3-prong grounding plug. To minimize possible shock hazard, the cord must be plugged into a mating 3-pronged and grounding-type wall receptacle, grounded in accordance with the National Electrical Code and local codes and ordinances. If a mating wall receptacle is not available, it is the personal responsibility of the customer to have a properly grounded, 3-prong wall receptacle installed by a qualified electrician.

#### CONNECTING THE POWER SUPPLY LINE

1. Unscrew the two screws holding the access cover and remove the cover. You will find two leads (black and white). See drawing below
2. Feed a power supply cord (not included) through the access cover and connect it with the two leads. The ground line should be connected to the grounding screw. The two connectors must be insulated. Put the access cover back in place.
3. You will find a strain relief bracket in the accessory package. Fix the power supply cord below the bracket, as shown in the previous illustration.
4. The other end of the power supply cord should be connected to an outlet that is in accordance with the local electrical code.

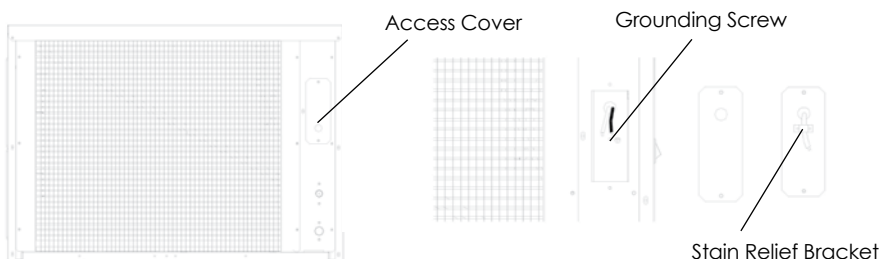

**Note: This machine is stackable on any of the machines in this manual. If the machine is to be stacked on top of another machine, a stacking kit will need to be installed. Refer to the installation instructions included with the stacking kit.**

## Ice Maker Installation

### WATER SUPPLY

The water supply should be ready at the point of installation. The water supply pressure should be a minimum of 15 psig with a static pressure not more than 80 psig. (A wall outlet directly behind the ice

### IMPORTANT:

1. All installations must be in accordance with local plumbing code requirements. Professional installation is recommended.
2. Water inlet fitting: 3/8" FPT (Female Pipe Thread); drain line connection: 1/2" FPT.
3. Make certain you have a suitable water supply hose and two suitable drain hoses, and that the hoses are not pinched, kinked or damaged during installation.
4. Check for leaks after connection.

**Tools required: 3/8" open-end wrench, Phillips screwdriver**

### Connecting the water line:

1. Turn off main water supply.
2. Find a water supply line near the installation location. The distance should be less than the length of the water supply hose.
3. A shut-off valve must be installed to the main water supply.
4. Connect the water supply hose to tap and water inlet valve. Tighten firmly by hand, then one-half turn with wrench.
5. Connect the water drain hose to drain line connection. Tighten firmly by hand, then one-half turn with wrench.
6. Turn on main water supply and tap. Check for water supply connection leaks. Tighten every connection (including connections at the water inlet).

### INSTALLATION TYPES

This ice maker has only been designed for mobile (free-standing) installation. There must be adequate air space around the unit for ventilation purposes.

### Mobile installation:

An enclosed installation will allow you to install the ice cube machine under a counter or in a kitchen cabinet provided the required clearance space around the ice maker is respected. You must follow the stated instructions for

- a. Electrical requirements
- b. Water supply

### Cleaning before use

After you remove all tape from the machine, clean the inside of your ice maker and ice storage bin before using them. See "Interior Cleaning" in the Cleaning and Maintenance section.



# MAXX ICE

## Operation

### FINAL CHECK LIST BEFORE OPERATION

1. Have all packing materials and tape been removed from the interior and exterior of the ice maker?
2. Did you clean the ice storage bin?
3. Have the installation instructions been followed, including connecting the machine to water and electricity?
4. Has the machine been leveled?
5. Is the ice cube machine in a site where the ambient temperature is between 50° F (10° C) and 100° F (38° C) and the water temperature between 41° F (5° C) and 90° F (32° C) all year round?
6. Has the water supply pressure been checked to ensure a minimum of 15 psig with a static pressure not to exceed 80 psig?
7. Is there a clearance of at least 6" (150 mm) at the rear, 1" (25 mm) at the top and sides for proper air circulation?
8. Has the power supply voltage been checked or tested against the nameplate rating? And has proper grounding been installed for the ice cube machine?
9. Is the ice cube machine plugged in?
10. Have you turned on the main water supply and the tap?
11. Have you checked for leaks at all water supply connections?

### OPERATING METHOD

1. Turn on the water tap; water enters the water tank. Then turn on the power switch; the red indicator LED of the power switch lights.
2. After 3 minutes, the ice maker will automatically proceed to the ice-making stage and the sound of flowing water will be heard.
3. When a batch of ice has been fully formed, it will be harvested into the ice storage bin automatically.
4. When the ice storage bin is full, the sheet of cubes will not fall completely and the water curtain opens, the microswitch will be kept open. The machine is in the Bin Full stage.
5. The unit will start making ice again after ice cubes are removed. At the same time, water curtain swings back to hold microswitch be in operating position.

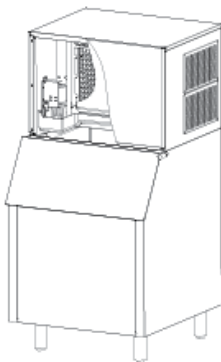

Ice-making stage

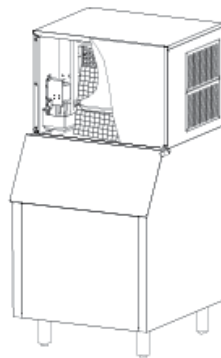

Ice harvest stage

### IMPORTANT:

- Although the unit has been tested and cleaned at the factory, due to long-term transit and storage, the first batch of cubes must be discarded.
- Never turn the water supply tap off when the ice maker is working.
- Never touch the evaporator when the machine is running.
- Except to take ice from the unit, keep the door closed to reduce melting and insure proper ice formation.

## Operation

### HOW THE MACHINE MAKES ICE

Turn the power switch to the ON position. After about 3 minutes the machine will automatically go into the ice-making stage.

There are two distinct cycles: freeze and harvest. During the freeze cycle, water flows to the evaporator surface. In the harvest cycle, the ice is released and water enters the machine. A complete cycle (freeze cycle and harvest cycle) takes 15 to 40 minutes, depending on temperature and operating conditions.

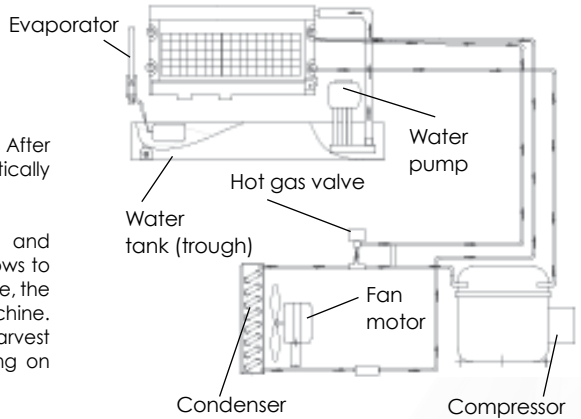

**Freeze:** During the freeze cycle the compressor is pumping refrigerant, the fan motor is blowing air, and the water pump is pumping water. When the batch of ice has been fully formed, the ice maker stops the freeze cycle and the harvest cycle start.

**Harvest:** During the harvest cycle, the compressor is still operating and power is supplied to the hot gas valve. Every 20 cycles, the water purge valve opens and allows the water pump to purge the water from the water tank, removing all impurities and sediment. This allows the machine to make clear ice cubes and keep mineral build-up at a minimum. Then the water pump stopped. When the hot gas valve opens, it allows hot gas to go directly to the evaporator. The gas warms the evaporator, causing the cubes to slide off the evaporator and into the storage bin. The freeze cycle will restart when all the cubes drop into the bin.

### HOW THE MACHINE USES WATER:

The ice maker begins with a fixed charge of water that is contained in the water tank. As the water flows to the freezing evaporator surface, the water freezes and sticks to the ice cube molds. During the ice-making process, fresh water enters the water tank continuously as the water from the tank freezes continuously on the evaporator.

### NORMAL SOUNDS

Your new ice cube machine may make sounds that are unfamiliar to you. Most of the new sounds are normal. Hard surfaces like the floor and walls can amplify the sounds. The following describes the kinds of sounds that might be new to you and what may be causing them.

- Rattling noises may come from the flow of the refrigerant or the water line. Items stored on top of the ice cube machine can also make noises.
- The high-efficiency compressor may make a pulsating or high-pitched sound.
- Running water may make a splashing sound.
- You may hear air being forced over the condenser by the condenser fan.
- During the Harvest cycle, you may hear the sound of ice cubes falling into the ice storage bin.

### PREPARING THE ICE CUBE MACHINE FOR LONG STORAGE

If the ice maker will not be used for a long time, or it is to be moved to another place, it will be necessary to drain water from the system.

1. Shut off the water supply at the main water source.
2. Disconnect the water supply pipe from the water inlet.
3. Depress the clean button and hold over six seconds, the machine will go into the draining mode automatically, with harvest and ice-making indicators blinking, till the water flush down the drain completely, then the harvest indicator and ice-making indicator LEDs will be on. And the drain process complete.
4. Shut off the power supply at the main electrical power source.
5. Dry the water tank.
6. Remove all ice cubes from the ice storage bin and dry it.
7. Keep the door opening to allow for ventilation and to prevent mold and mildew.
8. Leave the water supply pipe and power cord disconnected until ready to reuse.

### IMPORTANT:

- Do not touch the power plug when your hands are wet.
- Never unplug the unit by pulling on the cord.



# MAXX ICE

## Cleaning and Maintenance

### CAUTION

If the ice maker is left unused for a long time, before the next use it must be thoroughly cleaned. Follow carefully any instructions provided for cleaning or use of sanitizing solution. Do not leave any solution inside the ice maker after cleaning.

Periodic cleaning and proper maintenance will ensure efficiency, top performance, and long life. The maintenance intervals listed are based on normal conditions. You may want to shorten the intervals if you have pets or there are other special considerations.

### WHAT SHOULDN'T BE DONE

Never keep anything in the ice storage bin other than ice: objects like wine and beer bottles are not only unsanitary, but the labels may slip off and plug up the drain.

### WHAT SHOULD BE KEPT CLEAN

There are 4 things to keep clean:

1. The exterior
2. The interior
3. Water distribution tube
4. The ice-making system cleaning

### ⚠ WARNING

Before proceeding with cleaning and maintenance operations, make sure the power line of the unit is disconnected and the water line is shut off. (EXCEPTION: Cleaning of ice-making system)

### EXTERIOR CLEANING

The exterior of the ice maker and bin may be cleaned with a soft cloth or sponge dampened with a mild detergent and warm water solution such as 1 oz of dishwashing liquid mixed with 2 gallons of warm water. Never use solvent-based or abrasive cleaning agents. Rinse with clean water. Wipe with a soft clean towel to prevent water spotting.

### INTERIOR CLEANING

Clean the water tank before the ice maker is used for the first time and reused after stopping for an extended period of time. It is usually convenient to sanitize the tank after the ice-making system has been cleaned and the ice storage bin is empty. The ice storage bin should be sanitized occasionally.

Follow these steps to clean the tank and the bin:

1. Disconnect power to the unit.
2. Remove ice machine front panel.
3. Using a sanitizing solution made of 1 ounce of household bleach and 2 gallons of hot water (95° to 115°F), wipe down the water tank and the inside of the ice storage bin with a clean cloth. To clean hard-to-reach corners, apply the sanitizing solution with a spray bottle.
4. Rinse thoroughly with clear water. This completes the interior cleaning of the ice maker and storage bin.
5. Reconnect power to the unit.

## Cleaning and Maintenance

### **⚠ WARNING**

DO NOT use solvent-based cleaning agents or abrasives on the interior. These cleaners may transmit taste to the ice cubes, or damage or discolor the interior.

#### **WATER DISTRIBUTION TUBE CLEANING**

When you find that the ice cubes are incompletely formed or the output of ice cubes is low, the water distribution tube may be blocked. Set the power switch to OFF. Unscrew the six screws holding the top panel and remove the panel. You will see the water distribution tube. Rotate the water distribution tube so that the holes in it are facing up. Using a toothpick or similar tool, dredge the holes, then rotate the water distribution tube back to its original position. If the tube is badly blocked, clean it as follows:

1. Shut off the water and power supplies.
2. Disconnect the water hose from the distribution tube.
3. Lift one side, remove the distribution tube.
4. With a brush, clean the tube with a dilute solution of warm water and a mild detergent such as dishwashing liquid. After removing the dirt and lint from the surface, rinse the tube with clean water.
5. Replace the distribution tube.
6. Reconnect the water supply and power supply lines.
7. Re-attach the top and front panels.

#### **ICE-MAKING SYSTEM CLEANING**

Minerals that are removed from water during the freezing cycle will eventually form a hard, scaly deposit in the water system. Cleaning the system regularly helps remove the mineral scale buildup. How often you need to clean the system depends on how hard your water is or how effective your filtration may be. With hard water of 15 to 20 grains/ gallon (4 to 5 grains/liter), you may need to clean the system as often as every 3 months.

1. Remove ice machine front panel.
2. Make sure all ice is off evaporator. If ice is being made, initiate harvest or wait for cycle completion, then turn machine off at the power switch.
3. Remove all ice cubes from the storage bin.
4. Keep the ice maker connected to the water supply. Pour 8 oz. of Nickel-Safe Ice Maker Cleaner Solution into the water tank.
5. Turn on the power switch. Within 3 minutes press the Clean button. The machine will go into the cleaning mode automatically.
6. The ice-making system cleaning cycle will continue for 30 minutes unless you press the power switch (you can press the power switch to stop the cleaning cycle any time during the 30 minutes). After cleaning, the harvest indicator and ice-making indicator LEDs will be on. The cleaning process stops.
7. Repeat steps 4 to 5 above three times to rinse the ice-making system thoroughly. This will complete ice-making system cleaning.  
(NOTE: Do not add Ice Maker Cleaner Solution to the water tank during the rinses.)
8. Perform steps 3 and 4 in the Interior Cleaning section.
9. If you want to make ice cubes after cleaning, turn off the power switch, then turn on the power switch. The next ice-making cycle will begin.
10. Discard the first batch of ice.



# MAXX ICE

## Cleaning and Maintenance

### **⚠ WARNING**

The ice machine cleaner contains acids.

DO NOT use or mix with any other solvent-based cleaner products.

Use rubber gloves to protect hands. Carefully read the material safety instructions on the container of the ice machine cleaner.

DISCARD the first batch of ice produced after cleaning.

### CONDENSER CLEANING

1. See drawing.
2. The air cooled condenser should be vacuumed once or twice per year to remove any lint that may have been drawn into it. Using a tool that seems like a probe to remove any lint from the condenser fins.

**NOTE: Do not touch condenser fins. They are sharp and can be damaged easily.**

Condenser

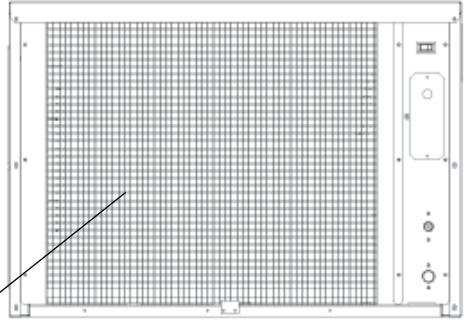

### Control Panel (at the left side of the machine)

You will find the control panel at the left side of the machine. This panel includes the clean button, the mode button and four LED indicators.

### OPERATION OF THE CONTROL PANEL:

1. When the unit is plugged in and the power switch is turned on, the power indicator and the other three indicator lights are all on.
2. After three minutes for water inlet, the ice maker will start to make ice automatically. Only the power and ice-making indicators will be on.
3. During harvest, the harvest indicator light is on and ice-making indicator off. When the ice storage bin is full, only the ice-full indicator and power indicator are on.

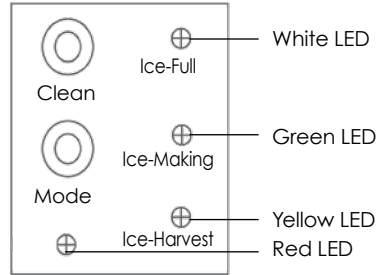

**NOTE: During the ice making cycle or harvest mode, the machine cannot enter the clean mode. Pressing the clean button during the ice-making or harvest mode, it will be ignored. The ice-making or harvest will continue.**

4. When you want to clean the machine, turn off the power switch first, then turn it on again. Press the Clean button within 3 minutes and the ice maker will start the cleaning mode, with harvest and ice-making indicators blinking. After 30 minutes, the cleaning mode stops and the harvest indicator and ice-making indicators are on steady. If you want to restart the ice-making process after cleaning, turn OFF the power switch first, then turn on the power switch again and the machine will automatically go into the ice-making process.
5. If you want to interrupt the cleaning mode before it is finished, do not press the Clean button again. Instead, turn the power switch off. This stops the cleaning cycle.
6. If the unit is connected to the power supply but no visual indicator lights up when the power switch is turned on, the fuse in the control panel box may need to be replaced.



## Control Panel (at the left side of the machine)

### DESCRIPTIONS OF LEDS AND BUTTONS:

1. **Red LED:** Power indicator
2. **WHITE LED:** Ice Full indicator light.  
When this LED is lit, the ice storage bin is full of ice or something is holding the water curtain open. The unit will stop working when this light is lit. When ice cubes are taken out of the ice storage bin, releasing the water curtain, the red LED will flash for 3 minutes. The unit will then restart and returns to the ice making mode.
3. **Green LED:** Ice Making indicator light.  
When this LED is lit, the unit is working in the Ice Making mode controlled by a temperature probe on the evaporator. When the green LED is flashing, the unit is working in the Ice Making mode controlled by a fixed timer.
4. **Yellow LED:** Ice Harvest indicator light.  
When this LED is lit, the unit is working in the Ice Harvest mode controlled by a temperature probe on the evaporator. When the yellow LED is flashing, the unit is working in the Ice Harvest mode controlled by a fixed timer
5. **Clean button:**  
When this button is pressed, the unit enters the Cleaning mode. The green and yellow LEDs flash together. To stop the Cleaning mode, just press the button again.
6. **Mode button:**  
*Recommended for service technician only.* When this button is pressed, unit can change from Ice Making mode to Ice Harvest mode or from Ice Harvest mode to Ice Making mode. You can judge the mode from the status of the green and yellow LEDs.

### ICE BRIDGE SIZE ADJUSTMENT GUIDE:

1. Press and hold the "Clean" button and the "Mode" button together for at least 3 seconds. The unit will enter the Ice Size Adjustment mode. The "ICE" LED (green) will be blinking continuously during the ice size adjustment.
2. While in the Ice Size Adjustment mode, press the "Clean" button or the "Mode" button for the desired ice size.

### SMALLER ICE SETTING:

By pressing the "Clean" button, you can decrease the size of the ice bridge. The "FULL" LED (red) will flash as you lower the ice size and will finally be blinking at the setting of smallest ice size.

### LARGER ICE SETTING:

By pressing the "Mode" button, you can increase the size of the ice bridge. The "HARVEST" LED (yellow) will flash as the larger size is set and will blink when the setting of largest ice size has been reached.

*After 10 seconds without any operation, the unit will automatically memorize the current state and return to the previous mode.*

#### NOTE:

- If during the ice size adjustment mode the "BIN FULL", "ICE MAKING" and "HARVEST" LEDS blink all at once, this indicates that the unit is in the regular (middle) setting of the ice size.
- When the machine is in the cleaning stage or ice full stage, the ice size adjustment mode cannot be accessed.

### IMPORTANT:

- The ice bridge adjustment has been set at the factory for optimum performance and it is not recommended for a user to make this adjustment. This ice adjustment procedure should therefore be made only by an authorized service technician.

## Troubleshooting

### BEFORE CALLING FOR SERVICE

If the unit appears to be malfunctioning, read through the OPERATION section of this manual first. If the problem persists, check the Troubleshooting Guide on the following page. The problem may be something very simple that can be solved without a service call.



## Troubleshooting Guide

PROBLEM	POSSIBLE CAUSE	PROBABLE CORRECTION
The machine doesn't operate	The ice maker is unplugged.	Plug the ice maker in.
	The fuse is blown.	Replace fuse. If it happens again, call for service to check for a short circuit in the ice maker.
	The ice maker power switch is OFF.	Turn the ice maker power switch ON.
	The ice storage bin is full of ice.	Remove some ice. Make sure water curtain and micro-switch are closed.
The water doesn't feed in after the ice maker starts.	The water supply tap is turn off.	Turn on the water supply line.
	The water supply pipe is not proper connected.	Reconnect the water supply pipe.
Machine makes ice, but bin does not fill up with ice	The condenser may be dirty.	Clean the condenser air filter.
	The air flow to the ice maker may be obstructed.	Check the installation.
	The ambient and water temperatures are high, or the machine is near some heat source.	Check the installation.
Water is leaking from the unit.	A few water drops fall to the floor when you open the door to take out ice from ice storage bin.	Normal condensation on the door or some water together with ice. Take care when you take out ice.
	Water supply connection leaks.	Tighten fitting. See "Connecting the water line".
Cubes are partially formed or white at the bottom.	Not enough water in the water trough.	Check if the water supply pressure is below 15 psig.
		Check water supply—filter may be restricted.
		Check for a water leak at the water trough.
Noise during operation	The feet are not leveled and locked.	Level and lock the feet. See "Leveling the Ice Maker".
	Certain sounds are normal.	See Normal Sounds.
The ice maker stops suddenly while making ice.	The electricity is off.	Reconnected the power supply line.
	The room temperature is out the stated range.	Cut off the electricity, let the ice maker stop working until the temperature returns within the stated range.
	The ice storage bin is full of ice.	Remove some ice cubes; Make sure the water curtain and micro-switch are close.
The body of the ice maker is electrified.	The grounding line isn't in the socket.	Use a socket meeting the required electrical standard.
Scaling occur frequently inside the machine.	The hardness of the water is too high.	Use a water-softening device installed in front of the water inlet.





 **MAXX ICE**

3355 Enterprise Ave., Suite 160 - Ft. Lauderdale, FL 33331  
T: (954) 832-3724 - F: (954) 202-7337  
[www.maxxfoodservice.com](http://www.maxxfoodservice.com)